

Knauf Windliner

An external sheathing board ideal for use with steel infill systems



Provides protection to the building during the construction programme for a period of up to 6 months

Reaction to fire classification A2-s1, d0

Easy and fast installation enabling fast closure of exterior walls



The Knauf Group operates in over 60 countries worldwide, providing construction materials and systems for dry lining, insulation, structural steel, floors and external renders.

Based on our knowledge and understanding of our full range of product areas, we combine the wealth of experience of our Group to offer simple and effective solutions for the facades market.

Developing strong working relationships with our customers is central to our ethos. We establish long-lasting collaborations, supported by our first class expert advice and service alongside our excellent quality products and systems.

One source; the right solution.



Contents

- 04** The ideal weather protection for the building envelope
- 06** System overview
- 08** Installing Knauf Windliner onto Knauf SFS
- 10** Performance, compliance and sustainability
- 12** Support
- 14** Case study



The ideal weather protection for the building envelope

Knauf Windliner has been developed for steel infill construction methods.

It is a 12.5mm paper-faced gypsum sheathing board designed to provide protection against the weather for the outer face of the Knauf Solid SFS stud.

Knauf Windliner has a fire and moisture resistant core and is faced with treated terracotta-coloured paper to reduce moisture ingress. Knauf Windliner may be exposed to external elements during a typical build programme without problems for up to 6 months. It offers many on-site benefits including a quick and easy cutting method – you can simply score and snap the boards. It can also be fixed without difficulty using the low-profile headed Knauf Windliner Screws, with no pre-drilling required, resulting in a faster installation compared to a traditional cement particle board. The boards themselves are also lighter than traditional cement particle boards, making them easier to handle and install on site.

Knauf Windliner does not require a breathable membrane, which helps save money and time for every project.

Typical constructions include steel framing system with a brick cladding or rainscreen cladding.

Steel Frame with brick cladding

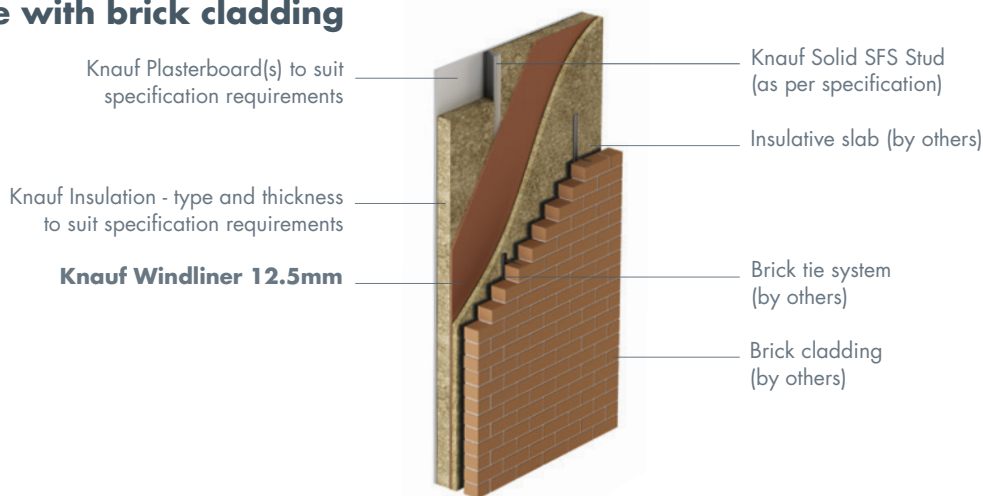

Steel Frame with rainscreen cladding

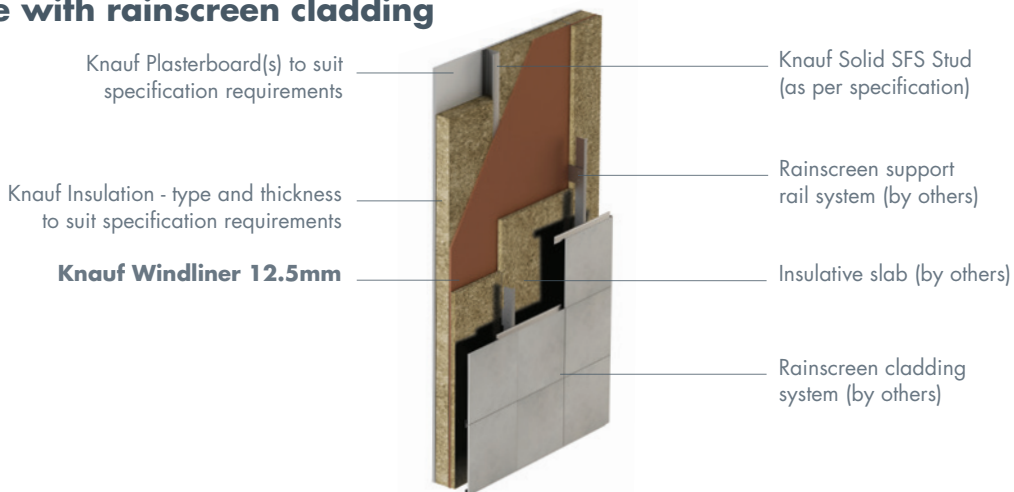

Features and benefits

- Airtight and moisture resistant solution - once boarded the building can be left exposed for up to 6 months when installed according to Knauf guidelines
- Fire reaction class A2-s1, d0, material of limited combustibility suitable for buildings of over 18m
- Lightweight board - easy to carry and install; faster to install compared to cement particle boards
- Simple installation - Easy to cut and fix, simply score and snap, no pre-drilling required
- Speedy installation enabling fast closure of exterior walls
- Removes the need for breathable membrane
- BBA certified



Knauf Windliner provides excellent performance in accordance with UK and European standards.





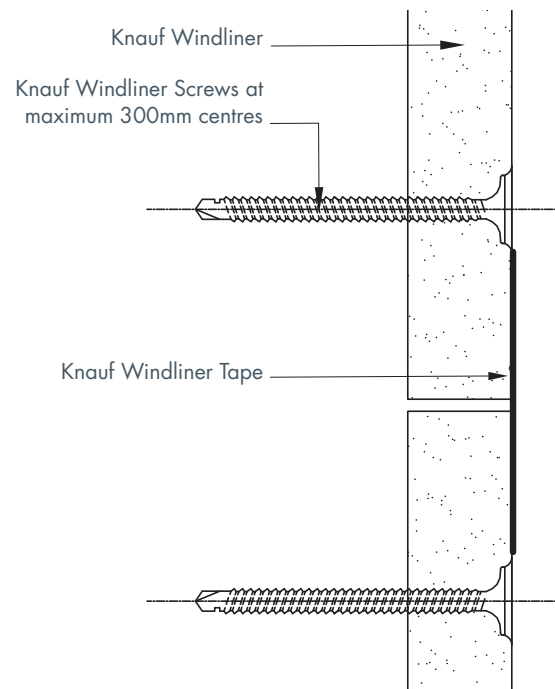

Knauf Windliner



Knauf Windliner and Accessories

Product	Properties	Performance and Standards
<p>Knauf Windliner</p> 	<p>Provides protection against the weather for the outer face of the Knauf Solid SFS stud.</p> <p>Dimensions: 2400mm x 1200mm</p> <p>Board thickness: 12.5mm</p> <p>Board weight: 10kg/m²</p> <p>Edge type: Square edge</p> <p>Density: 800kg/m³</p> <p>Manufactured to: BS EN 520:2004+A1:2009, type E F & H1</p>	<p>Air tightness: excellent performance when installed and sealed in line with recommendations - Airflow rate at 50 Pa (m³/m²h Pa) 0.001 - BS EN 12114:2000</p> <p>Moisture resistance: H1 classification - BS EN 520:2004+A1:2009</p> <p>Water vapour resistance: Type E - BS EN 12572:2016 and BS EN 520:2004+A1:2009</p> <p>Reaction to fire: A2-s1, d0 - BS EN 520:2004+A1:2009</p> <p>Thermal conductivity: 0.243W/mK BS EN 12667:2001</p>
<p>Knauf Windliner Screws</p> 	<p>For attachment of Knauf Windliner to Knauf Solid SFS studs.</p> <p>Dimensions: 25mm and 38mm lengths for fixing capacity of 13mm and 26mm respectively.</p> <p>Diameter: 3.5mm</p>	<p>Corrosion resistance: 500 hour salt spray corrosion resistance</p> <p>Reaction to fire: A1 - EN 14566:2008+A1:2009</p>
<p>Knauf Windliner Tape</p> 	<p>For sealing joints exposed edges on Knauf Windliner.</p> <p>Dimensions: Widths 60mm and 100mm available</p> <p>Highly UV and moisture resistant. Excellent adhesive bond.</p>	<p>UV resistance: 12 months - BS EN 1849-2:2009</p> <p>Bonding strength: Approx. 35N/25mm - BS EN 1372:2000 and 1373:2015. DIN EN 1939</p>



Installing Knauf Windliner onto SFS



Scoring Knauf Windliner with a knife.



Fixing the boards to the Knauf SFS Studs.



Taping the joints with Knauf Windliner Tape.

1. Cutting

Knauf Windliner can be cut on site using the score and snap method. If trimming is required once the board is installed, a padsaw may be used.

2. Fixing

Boards are fixed in an upright position with both bound edges supported by a stud. Boarding should commence at the bottom of the panel filling in the section between columns. Board joints and exposed edges should be sealed with Knauf Windliner Tape.

The boards are lightly butted together and mechanically fixed to the studs at a maximum of 300mm centres (200mm around openings and to external corners) using Knauf Windliner Screws.

Knauf Windliner should be fixed at a maximum of 15mm from the vertical edge of the board and a maximum of 13mm from the horizontal edge of the board. Knauf Windliner Screws are designed to sit tight on the surface of the board without breaking through the board's paper lining. This is important to prevent moisture ingress.

When forming corners, it is good practice that exposed edges of Knauf Windliner have bound edges. If exposed edges are unavoidable you should protect the edges with Knauf Windliner Tape whilst the boards are exposed.

3. Sealing

Joints between Knauf Windliner boards should be sealed using Knauf Windliner Tape.

4. Mechanical fixings for cladding and rail systems

All mechanical fixings to support rail systems or insulation should be fixed back to the Knauf SFS studs only. Please contact the relevant manufacturer for further advice.

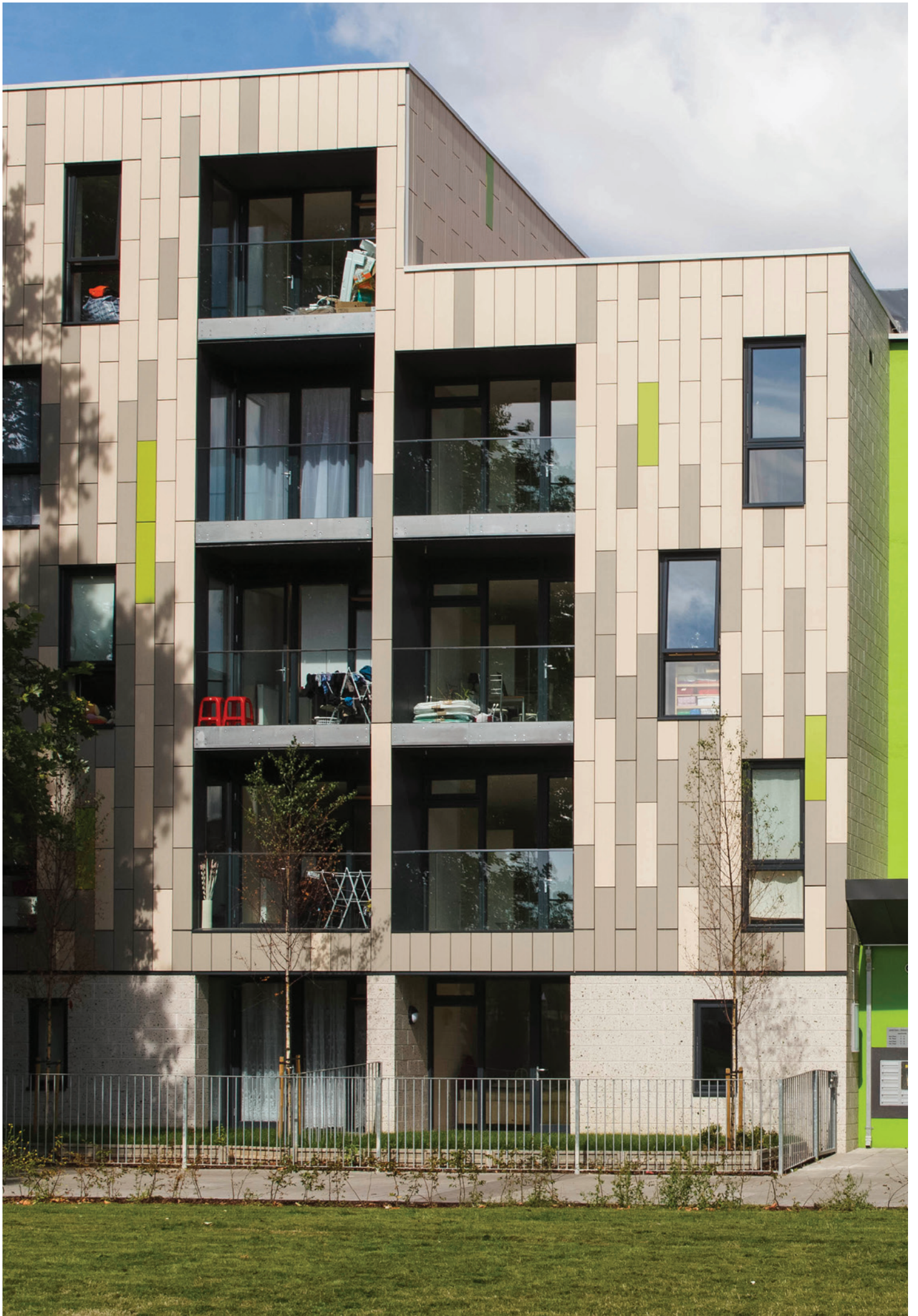

Performance

Our systems use Knauf materials throughout. Knauf Windliner and accessories are manufactured to strict British and European Standards and are thoroughly independently tested together as complete, warranted systems.

Our Knauf Windliner board is tested by BBA for its strength and stability, behaviour in relation to fire, moisture absorption and durability. The design is certified suitable for non-loadbearing application onto steel frame systems and can be expected to have a service life equal to that of the building in which it is installed. The system also complies with the latest NHBC standards.



Compliance

All Knauf products affected by the Construction Product Regulation (CPR), including Knauf Windliner are fully compliant and CE marked.

DoP and MSDSs for the products are available for download on our website.

Sustainability

- Knauf Windliner contains an average of 96% recycled content
- Local UK production in manufacturing sites certified to ISO 9001, ISO 14001, ISO 50001, OHSAS 18001 and BES 6001
- Knauf Windliner can contribute to systems achieving BRE Green Guide ratings of A and A+
- Knauf Windliner contributes to increased air-tightness of the building
- The thermal conductivity of Knauf Windliner is 0.243W/mK.



Business Development Team

Our Project Specification Engineers (PSEs) and Project Specification Managers (PSMs) can provide help and support throughout the duration of your project. They are often involved with the entire supply chain from the distributor through to the client, speeding up the flow of information and spotting and eliminating likely issues. Our PSEs and PSMs are all highly skilled and technically qualified, and specialise in bespoke design and value engineering large projects.

For any queries in the UK and Ireland please email infofacades@knauf.co.uk

The Technical Services Team

Our office-based Design Engineers (DEs) in exterior systems and our Technical Support Officers (TSOs) work hand in hand with our PSE team, providing design backup and a quick response to all your technical enquiries. Our DEs and TSOs are all technically qualified and enjoy comprehensive and ongoing training. The two teams have an excellent working relationship – enhancing the level of service you can expect from us.

Call 0800 030 4135 for technical advice.

For queries, please email infofacades@knauf.co.uk

U-value Calculations

Calculations are provided to demonstrate the performance of our insulation products and compliance with Building Regulations. All U-values are calculated by the Combined Method, in accordance with the conventions detailed in BRE 443 (2006), BS EN ISO 6946:2017.

For any queries in the UK and Ireland please email infofacades@knauf.co.uk

Project data

Project: Middlewood Locks,
North-West, England

Project outline: Mixed-use residential and detail
development in Salford

Value: £700m

Client: Scarborough Group International

Architect: Whittam Cox Architects

Main contractor: BCEGI Construction

Subcontractor: SCS

Products: Knauf Windliner

Summary: For such an important
development, it was essential
to use a high quality product
that was also cost-efficient. That
is why subcontractor SCS chose
to use Knauf Windliner instead of
the originally specified traditional
cement-based material.



Knauf's Windliner helps subcontractor in major mixed-use development.

Knauf's Technical Services Team played a critical role during the construction of the first phase of a brand new mixed-use residential and retail development in Salford.

BCEGI Construction's £700m Middlewood Locks development is one of the most sought-after sites in Salford, centred around the Manchester, Bolton and Bury Canal and with key employment space and major transport infrastructure close by.

For such an important development, it was essential to use a high quality product that was also cost-efficient. That is why subcontractor SCS chose to use Knauf Windliner instead of the originally specified traditional cement-based material.

Darren Friend, Commercial Director at SCS, said that the ease of installation offered by Knauf Windliner gave the product an edge over its competitors.

"Having the full system of accessories all supplied and warranted by Knauf has made our life easier rather than sourcing from multiple suppliers," said Darren.

"Knauf provided a lot of assistance throughout the project, providing all technical data and information needed by our client to get their change through building control and their insurance providers. They also did numerous site visits throughout the project and reports for our client on the quality of the installation."

Knauf Windliner was put to the test when unforeseen circumstances meant the building's insulation had to be removed. This left Knauf Windliner exposed to the inclement British weather for six months whilst the insulation and external façade were re-applied.

Contractors were safe in the knowledge that Knauf Windliner has been independently tested and third-party certified by the British Board of Agrément for its water resistance and weather-tightness during the construction phase and prior to the installation of the external façade.

Darren added: "SCS had used Knauf Windliner on a couple of small projects previously but this was the first large scale project with in excess of 14,500m² and we are very impressed with it. We are very satisfied with both the product and service provided and will be putting Knauf forward on future projects."

Used on numerous construction projects throughout the UK and Europe, Knauf Windliner provides the ideal solution for architects and contractors seeking an external sheathing board that will protect their buildings regardless of the elements.

The boards are significantly lighter than traditional cement particle board, allowing for easier handling on site and faster installation times.

Manufactured from gypsum rather than cement, boards can be manipulated on site by simply scoring and snapping to the required size and shape. Speed of construction is even further accentuated because the boards require no specialist fixings and no pre-drilling is necessary.

The first apartments at Middlewood Locks have been made available to buy and construction of the first phase was completed in Spring 2018.





Customer Service

UK Exteriors Team Tel: 0800 032 6283
UK General Services Tel: 0800 521 050
Eire Tel: 01 4620739
Email: orders@knauf.co.uk

Technical Service

UK Tel: 0800 030 4135
Eire Tel: 01 4620739
Email: technical@knauf.co.uk

Literature

UK Tel: 03700 613 700
Eire Tel: +44 3700 613 700

Website

www.knauf.co.uk
www.knauf.ie

Knauf
Kemsley Fields Business Park
Sittingbourne
Kent ME9 8SR

Knauf
87 Broomhill Road
Tallaght
Dublin 24



 /KnaufUK
 @Knauf_UK